

# H O V D E N

OF NORWAY 1945



SCANDINAVIAN *Touch*





*Scandinavian Touch 4-seater sofa, 1-seater and pouf with storage. Cape armrest, cylinder oak legs, natural oiled.*



# SCANDINAVIAN *Touch*

*Scandinavian Touch is a high quality modular sofa adoptable for your needs.*

*Inspired by good Scandinavian design we have made your next sofa both*

*beautiful and very comfortable. It is a good and safe sofa choice.*

*Scandinavian Touch is developed together with renowned Norwegian*

*furniture designer Olav Eldøy.*

**H O V D E N**  
OF NORWAY 1945

Scandinavian Touch has a nice design, is great to sit in and will withstand long-term use. To verify your sofa purchase we have made some choices for you. The construction is solidly handcrafted and with measures that are ergonomically optimized. Body and frames are constructed of solid wood and plywood. We have used generous thickness in the high resilient foam of seat cushions. Back cushions have a core of high resilient foam and are swept with fiber for a rounded and soft comfort. Both seat- and back cushions are reversable and have removable covers.

**We invite you to make the choices that makes your sofa unique and special:**

First you choose which size and setup that suit your needs.

Then, choose armrest design, leg type, fabric and color.

Create the perfect sofa for yourself.

We guarantee you a quality sofa in good Scandinavian design.





*Scandinavian Touch 3-seater with open corner.  
Frost armrest and squared whiteoiled legs.*





# SCANDINAVIAN *Touch*

*A high quality sofasystem in Scandinavian design with careful attention to details. The construction is solidly handcrafted and with measures that are ergonomically optimized. A very nice sofa produced according to the best of Norwegian handcraft traditions.*





## Armrest and leg choices

Armrests - on Light and Frost there is an additional option to place leg right under armrest.



Cape  
Width: 5 cm



Light  
Width: 10 cm



Frost  
Width: 12 cm



Wave  
Width: 13 cm

## Leg choices



Squared oak  
H 14 cm



Round oak  
H 14 cm  
D 4,5 cm



Cylinder oak  
H 14 cm  
D 4 cm



Black metal  
H 14 cm

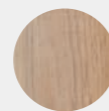

White  
oiled oak

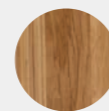

Natural  
oiled oak

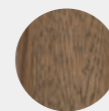

Grey  
oiled oak

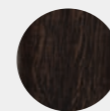

Smoked  
oiled oak

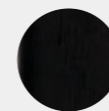

Black  
stained oak

## Modules

Add the width of your chosen armrest to get the total measure.  
Create your own Scandinavian Touch - all modules can be combined.

### Modules

1-seater

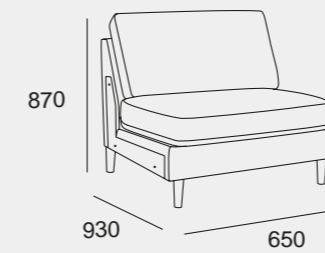

Chaiselong

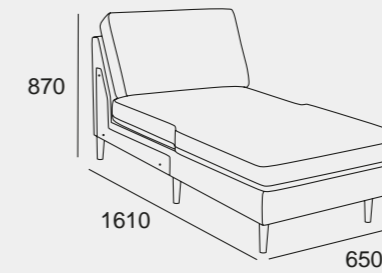

2-seater

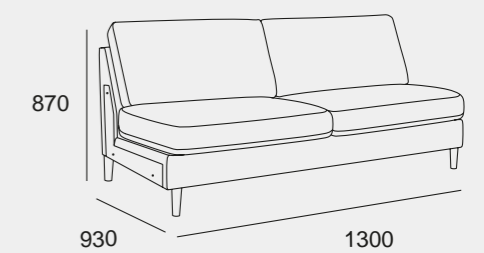

3-seater

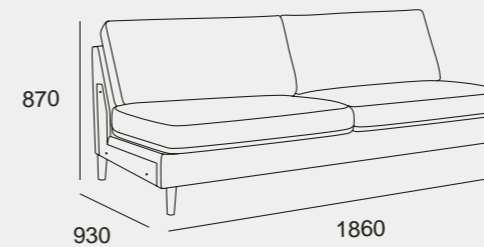

4-seater

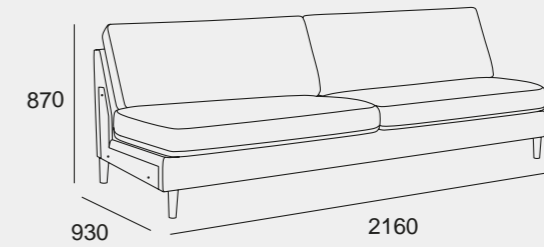

Open corner -left

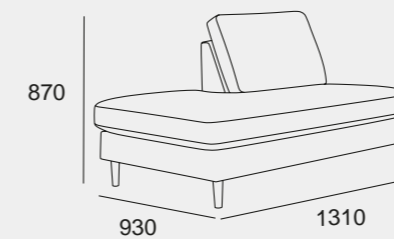

Open corner -right

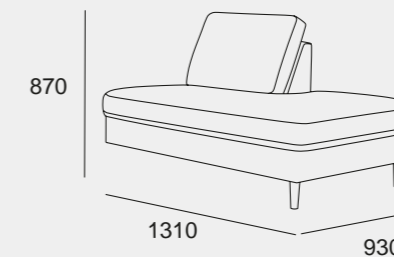

Corner

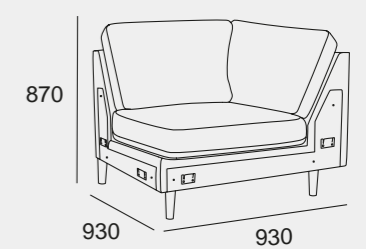

# Customize your Scandinavian Touch to fit your room and style!

Different modules, fabrics and leg choices allow you to create your own Scandinavian Touch. Below are popular setups. All measures are shown with Light armrest (10 cm). Common for all: seat height 43 cm. Seat depth 53 cm.

1-seater

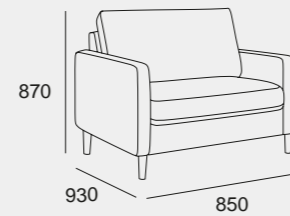

Chaiselong

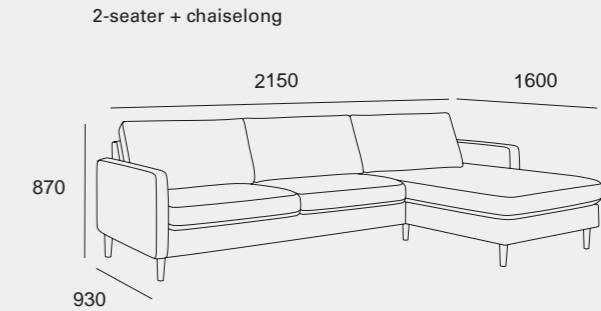

2-seater

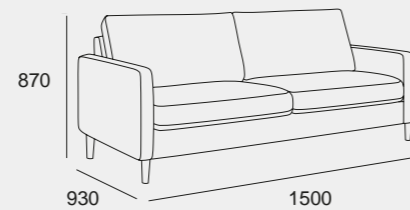

Open corner

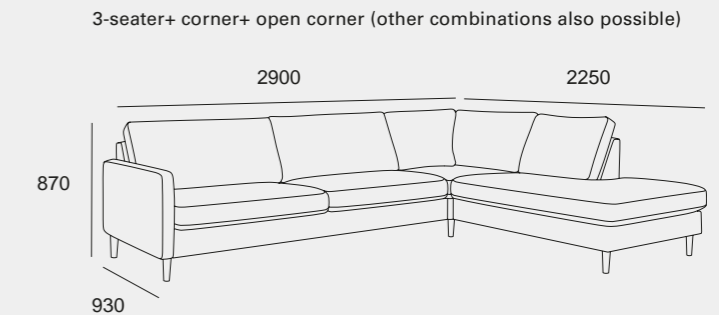

3-seater

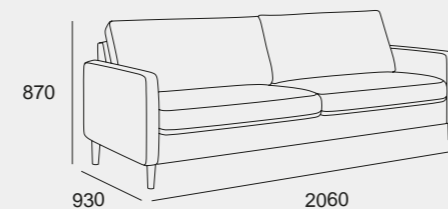

Standard corner

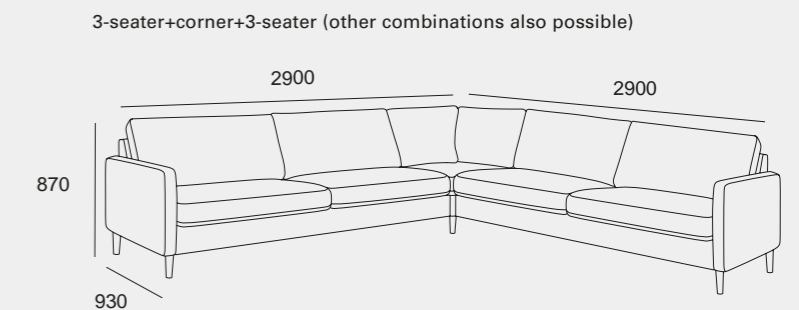

4-seater

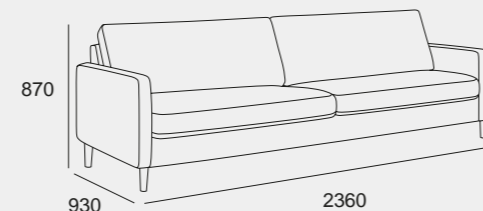

Chair

Low back chair



High back chair



Footrest



Pouf with storage





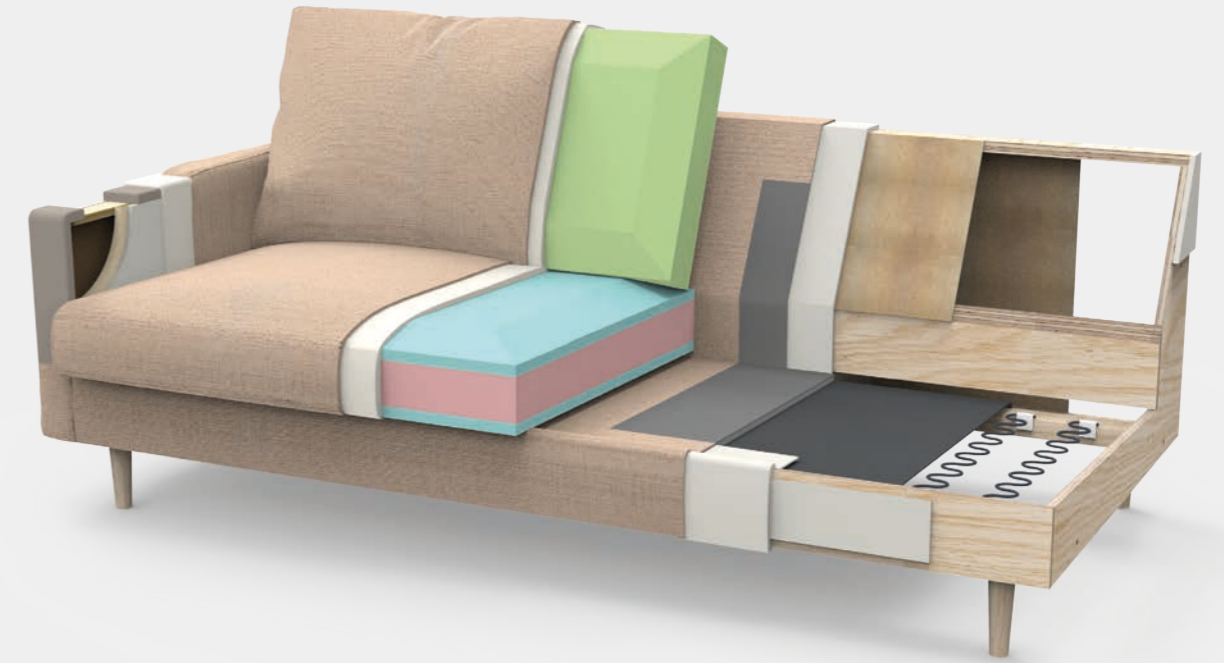

- Designed for optimal sitting comfort
- Handcrafted quality
- Sustainable materials
- Frame made from solid wood and plywood
- Leg choices in oak or metal
- Reversible cushions with removable covers
- High resilient foam in cushions
- Solid construction

### Fabric



Hovden offers a rich fabric collection. All selected fabrics satisfy the requirements for hard use and are from certified high quality weaving mills.

Properties are stated on the samples and can be viewed at your nearest Hovden furniture dealer.

### Additional products



Neck rest



Mid-armrest



Side table



Magazine holder



# H O V D E N

OF NORWAY 1945



**3 YEAR WARRANTY**  
mechanisms and frames



**75 YEARS**  
of proud traditions